

The background features a stylized world map in shades of blue and green, overlaid with a network of white lines and dots representing data connections. The overall aesthetic is futuristic and technological.

netsys

Networking your world

NV-202P

LAN extender with PoE

USER'S MANUAL

[Http://www.netsys.com.tw](http://www.netsys.com.tw)



Copyright

Copyright © 2012 by National Enhance Technology Corp. All rights reserved.

Trademarks

NETSYS is a trademark of National Enhance Technology Corp.

Other brand and product names are registered trademarks or trademarks of their respective holders.

Legal Disclaimer

The information given in this document shall in no event be regarded as a guarantee of conditions or characteristics. With respect to any examples or hints given herein, any typical values stated herein and/or any information regarding the application of the device, National Enhance Technology Corp. hereby disclaims any and all warranties and liabilities of any kind, including without limitation warranties of non-infringement of intellectual property rights of any third party.

Statement of Conditions

In the interest of improving internal design, operational function, and/or reliability, NETSYS reserves the right to make changes to the products described in this document without notice. NETSYS does not assume any liability that may occur due to the use or application of the product(s) or circuit layout(s) described herein.

Maximum signal rate derived from IEEE Standard specifications. Actual data throughput will vary. Network conditions and environmental factors, including volume of network traffic, building materials and construction, and network overhead, lower actual data throughput rate. Netsys does not warrant that the hardware will work properly in all environments and applications, and makes no warranty and representation, either implied or expressed, with respect to the quality, performance, merchantability, or fitness for a particular purpose. **Make sure you follow in line with the environmental conditions to use this product.**

Foreword: VDSL2 solution

Attention:

Be sure to read this manual carefully before using this product. Especially Legal Disclaimer, Statement of Conditions and Safety Warnings.

NV-202P is a Long Reach Ethernet Extender with PoE equipped with two 10/100Mbps Ethernet ports with power injector. It delivers data and electrical power to access points using standard Category 5 Ethernet cable that provide an economical solution for commercial-grade applications.

Operators in various enterprises will now be able to deploy PoE devices in any service location, install network security cameras, wireless access point security / VOIP, or access control systems in any place where you have basic wire connectivity.

The NV-202P also supports both central office (CO) and customer-premises equipment (CPE) modes selectable through DIP Switch.

Compliant with ITU-T G.993.2 VDSL2 standard, the NV-202P supports a maximum bandwidth of up to 100Mbps symmetric in VDSL2 solution. Since VDSL2 has the characteristic of higher bandwidth over shorter distances, the ideal architecture for Telecoms is to use fiber optic lines as the backbone and a VDSL2 line as the last mile into the home or office. With outstanding throughput, the NV-202P can complement a fiber network to offer the best solution for delivering Triple play(Video/Voice/Data) or home entertainment services.

Caution:

The NV-202P is for **indoor** applications only. This product does not have waterproof protection, please do not use in outdoor applications.

Safety Warnings

For your safety, be sure to read and follow all warning notices and instructions before using the device.

- ◆ **DO NOT** open the device or unit. Opening or removing the cover may expose you to dangerous high voltage points or other risks. ONLY qualified service personnel can service the device. Please contact your vendor for further information.
- ◆ **Use ONLY** the dedicated power supply for your device. Connect the power to the right supply voltage (110V AC used for North America and 230V AC used for Europe. NV-202P supports 48V~54V DC power input
- ◆ **Place** connecting cables carefully so that no one will step on them or stumble over them. DO NOT allow anything to rest on the power cord and do NOT locate the product where anyone can work on the power cord.
- ◆ **DO NOT** install nor use your device during a thunderstorm. There may be a remote risk of electric shock from lightning.
- ◆ **DO NOT** expose your device to dampness, dust or corrosive liquids.
- ◆ **DO NOT** use this product near water, for example, in a wet basement or near a swimming pool.
- ◆ **Connect ONLY** suitable accessories to the device.
- ◆ **Make sure** to connect the cables to the correct ports.
- ◆ **DO NOT** obstruct the device ventilation slots, as insufficient air flow may harm your device.
- ◆ **DO NOT** place items on the device.
- ◆ **DO NOT** use the device for outdoor applications directly, and make sure all the connections are indoors or have waterproof protection place.
- ◆ **Be careful** when unplugging the power, because it may produce sparks.
- ◆ **Keep** the device and all its parts and accessories out of the reach of children.
- ◆ **Clean** the device using a soft and dry cloth rather than liquid or atomizers. Power off the equipment before cleaning it.
- ◆ This product is **recyclable**. Dispose of it properly.

TABLE OF CONTENTS

COPYRIGHT	1
FOREWORD: VDSL2 SOLUTION	2
SAFETY WARNINGS	3
CHAPTER 1. UNPACKING INFORMATION.....	6
1.1 Check List	6
CHAPTER 2. INSTALLING THE BRIDGE.....	7
2.1 Hardware Installation.....	7
2.2 Pre-installation Requirements	7
2.3 General Rules	8
2.4 Connecting the Bridge.....	9
2.5 Connecting the RJ-11 / RJ-45 Ports	10
2.6 VDSL2 bridge Application	12

CHAPTER 3: HARDWARE DESCRIPTION	14
3.1 Front Panel.....	15
3.2 Front Indicators	16
3.3 Rear Panel	18
APPENDIX A: CABLE REQUIREMENTS	24
APPENDIX B: PRODUCT SPECIFICATION	26
APPENDIX C: DIN-RAIL MOUNT INSTALLATION.....	29
APPENDIX D: TROUBLESHOOTING	30
APPENDIX E: COMPLIANCE INFORMATION	36
WARRANTY	39
CHINESE SJ/T 11364-2014	40

CHAPTER 1. UNPACKING INFORMATION

1.1 Check List

Carefully unpack the package and check its contents against the checklist.

Package Contents:

<p>1 x NV-202P</p>	<p>1 x QR code for user's manual hyperlink.</p>	<p>Accessory: 4 x Rubber Feet , 1 x DC 48V~54V /1.875A Desktop Adapter, 1x AC to DC Power cord</p>

Notes:

1. Please inform your dealer immediately for any missing or damaged parts. If possible, retain the carton including the original packing materials. Use them to repack the unit in case there is a need to return for repair
2. If the product has any issue, please contact your local vendor..
3. Do not use sub-standard power supply. Before connecting the power supply to the device, be sure to check compliance with specifications. The NV-202P support DC 48V~54V / 1.875A power input.
4. The power supply included in the package is commercial-grade. Do not use in industrial-grade applications.
5. If you would like to use the telephone, please purchase a suitable external splitter and install to the line port.
6. Please look for the QR code on the bottom of the product, the user can launch the QR code scanning program to scan and download the user's manual electronic format file. Above QR code icon is for reference.

Chapter 2. Installing the Bridge

2.1 Hardware Installation

This chapter describes how to install the bridge and establish the network connections. The NV-202P may be installed on any level surface (e.g. a table or shelf or rail). However, please take note of the following minimum site requirements before one begin.

2.2 Pre-installation Requirements

Before you start the actual hardware installation, make sure you can provide the right operating environment, including power requirements, sufficient physical space, and proximity to other network devices that are to be connected.

If you experience any error or problem, please be sure, Netsys will care for you and the problem. Please contact your local dealer for support. If you are told to send the device for RMA and repair, ALWAYS ship the whole device with power supplies.

Verify the following installation requirements:

- Power requirements: **DC 48V~54V power.**
- The bridge should be located in a cool dry place, with at least **10cm/4in** of space at the front and back for ventilation.
- Place the bridge away from direct sunlight, heat sources, or areas with a high amount of electromagnetic interference.
- Check if the network cables and connectors needed for installation are available.
- **Do not install phone lines strapped together with AC power lines, or telephone office line with voice signal.**
- **Avoid installing this device with radio amplifying station nearby or transformer station nearby.**

2.3 General Rules

Before making any connections to the bridge, please note the following rules:

- **Ethernet Port (RJ-45)**

All network connections to the bridge Ethernet port must be made using Category 5 UTP/STP or above for 100Mbps, Category 3, 4 UTP for 10Mbps.

No more than 100 meters of cabling may be use between the MUX or HUB and an end node.

- **VDSL2 Port (RJ-11)**

All network connections to the RJ-11port must use **24~26** gauge with **twisted pair** phone wiring.

We **do not recommend** the use of the telephone line 28 gauge or above.

The RJ-11 connectors have six positions, two of which are wired. The router uses the center two pins. The pin out assignment for these connectors is presented below.

Please note that the line port is no polarity, therefore user can reverse the two wires of the phone cable when installed.

RJ-11 Pin out Assignments

Pin#	MNEMONIC	FUNCTION
1	NC	Unused
2	NC	Unused
3	DSL	Used
4	DSL	Used
5	NC	Unused
6	NC	Unused_

- **External Splitter**

Our devices support both ISDN interfaces U(2w) and S/T(4w). When using an external splitter, make sure that you are using one that is compatible with the interface you want to use.

2.4 Connecting the Bridge

The bridge has two Ethernet ports which support connection to Ethernet operation and PoE function. The devices attached to these ports must support auto-negotiation or 10Base-T or 100Base-TX unless they will always operate at half duplex. NV-202P fast Ethernet port is used to connect to external power splitter(PoE) or build in power splitter of networking devices such as IP CAM, VOIP, wireless AP, sensor scanner or other power splitter(PD side) more than 30W.

Notes:

1. The RJ11 Line port is used to connect the telephone that is connected to VDSL2 CO and CPE bridge (Point-to-point solution).
2. The Slave device (CPE) must be connected to the Master device (CO) through the telephone wire. The Slave cannot be connected to another Slave, and the Master cannot be connected to another Master. Please confirm the **DIP switch status** before the link is established.

2.5 Connecting the RJ-11 / RJ-45 Ports

- ◆ The line port has 2 connectors: RJ-45 and terminal block. It is used to connect from NV-202P (CO) using single pair phone cable to NV-202 (CPE) side (point to point solution). Take note that NV-202P line port cannot be used at the same time. Either RJ-11 port is connected or terminal block is connected using straight connection (Figure 2.4) or cross-over connection (Figure 2.5)

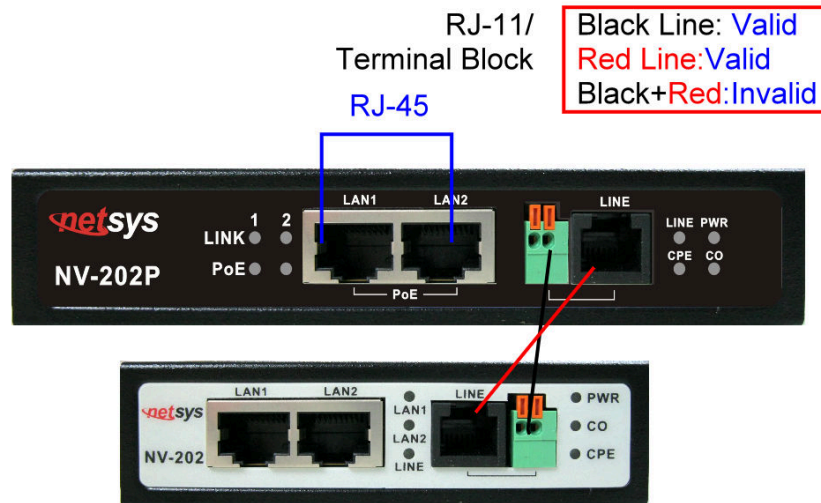

Figure 2.4 NV-202P line ports straight connection

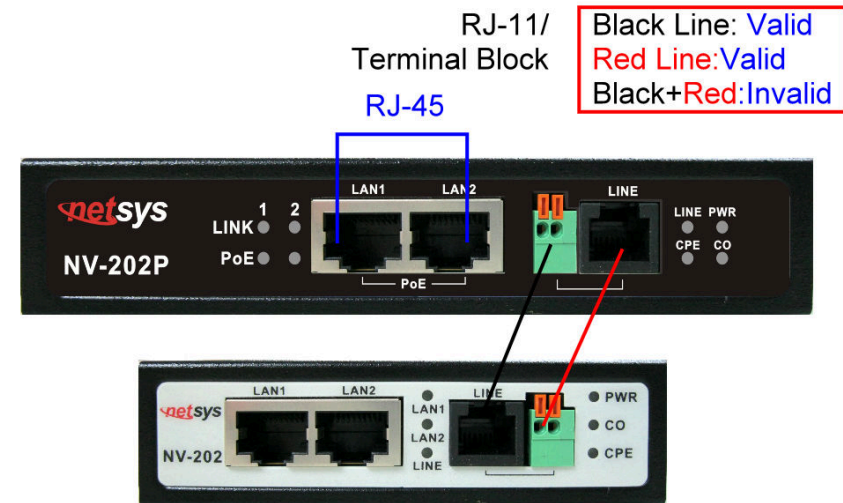

Figure 2.5 NV-202P line ports crossover connection

- ◆ When inserting a RJ-11 plug, make sure the tab on the plug clicks into position to ensure that it is properly seated.
- ◆ **Do not** plug a RJ-11 phone jack connector into the Ethernet port (RJ-45 port). This may damage the bridge. Instead, use only twisted-pair cables with RJ-45 connectors that conform to Ethernet standard.

Notes:

1. Be sure each twisted-pair cable (RJ-45 Ethernet cable) does not exceed 100 meters (333 feet).
2. We recommend use Category 5~7 UTP/STP cables for Cable bridged or Bridge connections to avoid any confusion or inconvenience in the future when you attached to high bandwidth devices.
3. Use **24 ~ 26** gauge twisted pair phone wiring, we do not recommend 28 gauge or above.
4. Be sure the phone cable has been installed before NV-202P is powered on.

2.6 VDSL2 bridge Application

1. User can use NV-202 bridge (CO mode) to connect NV-202P bridge (CPE mode), or use NV-202P bridge (CO mode) to connect NV-202 bridge(CPE mode) that to do a variety of applications. The bridge's line port supports 100Mbps maximum for data service across existing phone wiring. It is easy-to-use which do not require installation of additional wiring. Every modular phone jack in the home can become a port on the LAN. Network devices can be installed via a telephone wire in any suitable distance. (depending on the speed) (Figure 2.6)

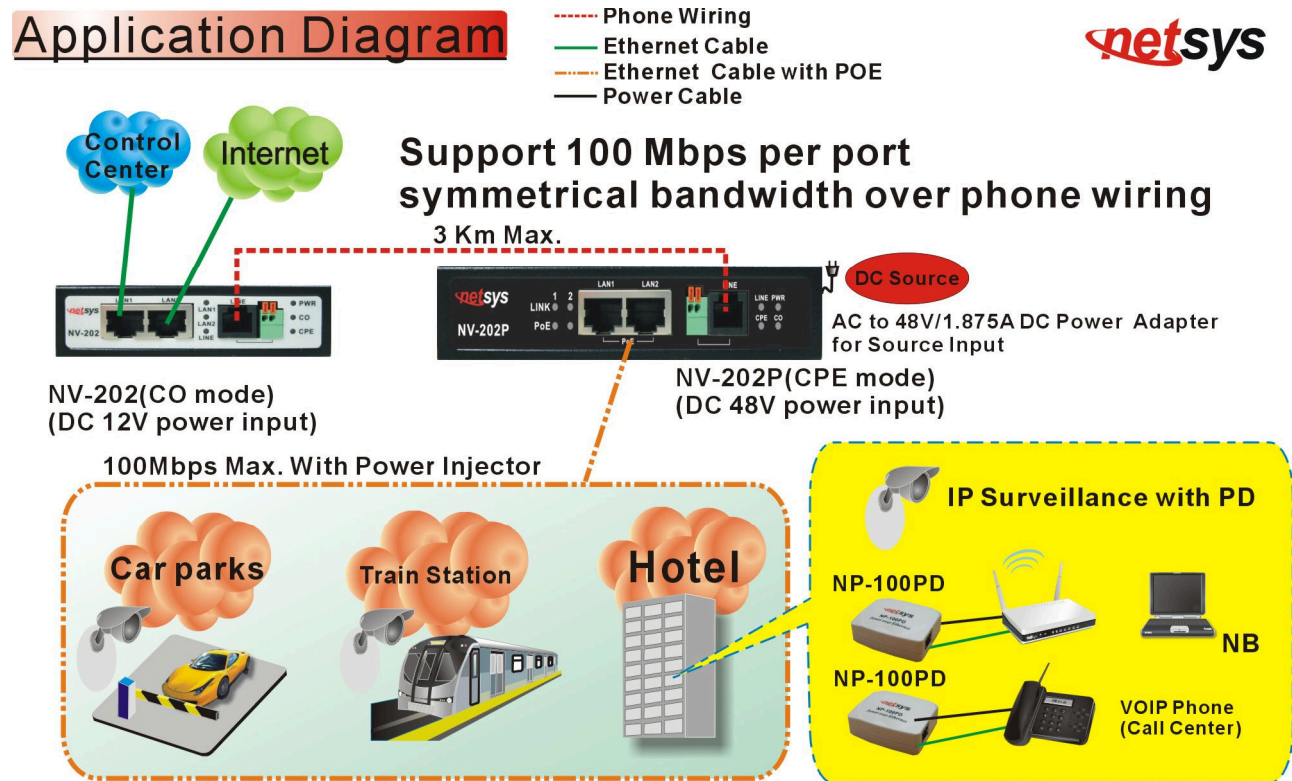

Figure 2.6 NV-202 / NV-202P point to point application diagram

2. If user need use over 1.5 km cable length and also need bigger bandwidth application, such as connect to ip camera. User can use NV-202P (CO mode) and NV-202 (CPE mode) to achieve the IP surveillance for long distance application. (Figure 2.7)

Application Diagram

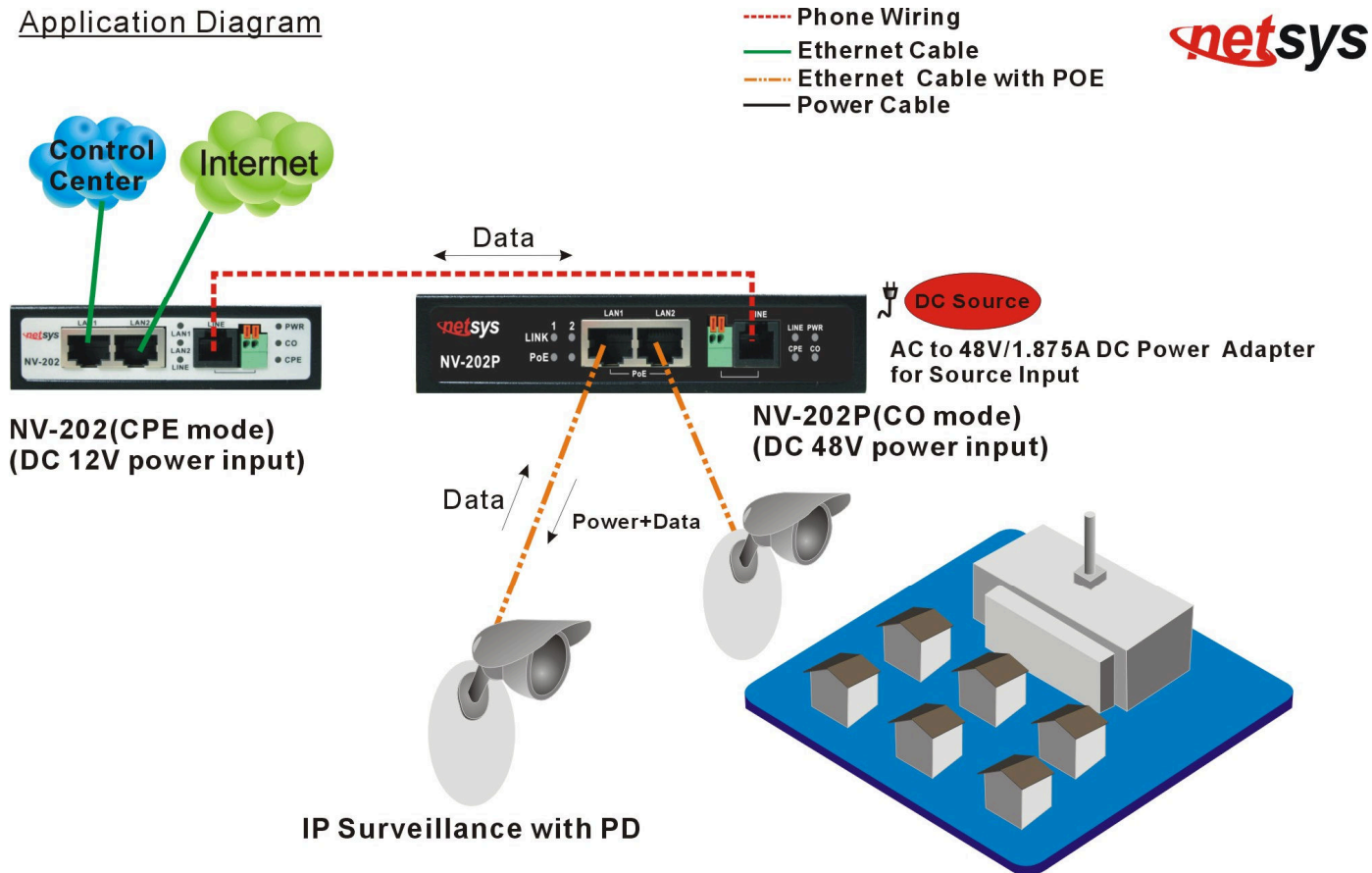

Figure 2.7 NV-202 / NV-202P point to point application diagram

Chapter 3. Hardware Description

This section describes the important parts of the bridge. It features the front panel and rear panel.



NV-202P Outward

3.1 Front Panel

The front panel provides a simple interface monitoring of the bridged. (Figure 3.1)

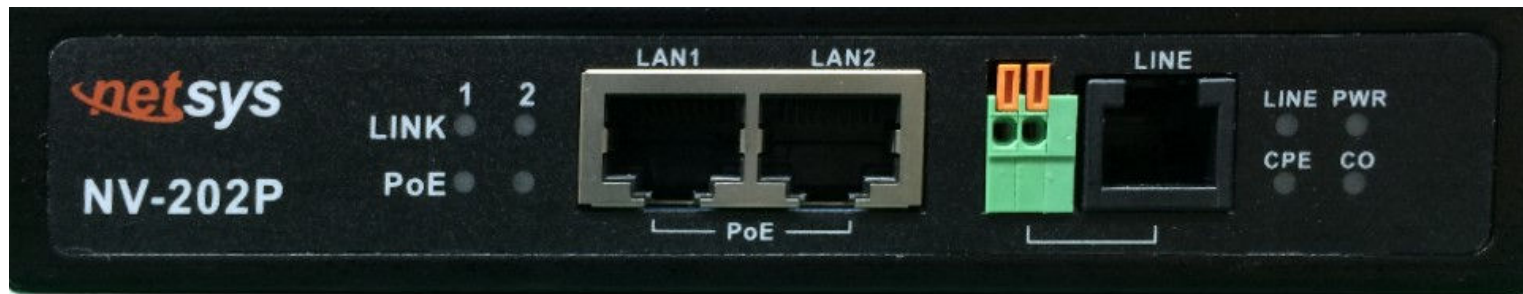

Figure 3.1 Front Panel

Tip:

At a quick glance of the front panel, it is easy to determine if it has Ethernet signal from its RJ-45 port and if there is vdsl line signal on RJ-11 port.

And the table shows the description. (Table 3-1)

Table 3-1 Description of the bridge front connectors

Connectors	Type	Description
LAN1 / LAN2	RJ-45	For connecting to an Ethernet equipped device.
Line	RJ-11/Terminal Block	For connecting to VDSL2 bridge. (Do not use RJ11 and Terminal Block at the same time.)

3.2 Front Indicators

The bridge has **Eight** LED indicators. The following Table shows the description. ([Table 3-2](#))

Table 3-2 LED Indicators Description and Operation

LED	Color	Status	Descriptions
PWR (Power LED)	Green	On(Steady)	Lights to indicate that the VDSL2 bridge had power
		Off	The device is not ready or has malfunctioned.
LAN 1-2 (Ethernet LED)	Green	On(Steady)	The device has a good Ethernet connection.
		Blinking	The device is sending or receiving data.
		Off	The LAN is not connected.
PoE 1-2 (PoE LED)	Green	On(Steady)	The device has a good PoE connection.
		Blinking	The device is detected to a PoE device, but the power supply does not feeding to the PD.
		Off	The device is not connected to a PD device yet.
CO (Local Side) (CO LED)	Green	On(Steady)	Indicate the VDSL2 bridge is running at CO(Master) mode.
CPE (Remote Side) (CPE LED)	Green	On(Steady)	Indicate the VDSL2 bridge is running at CPE(Slave) mode.
LINE (VDSL LINK LED)	Green	On(Steady)	The Internet or network connection is up.
		Blinking slowly	The CO device is auto-detecting CPE device.
		Blinking fastly	1. The CO device has detected a CPE device and ready to connect. 2. The device is sending or receiving data.
		Off	The Internet or network connection is down or has malfunctioned.

Note:

It is normal for the connection between two bridged to take up to 3 minutes, due to NV-202P to establish a link mechanism in auto-negotiation, that detects and calculates CO and CPE both PBO and PSD level, noise levels and other arguments for getting a better connection.

3.3 Rear Panel

The following figure shows the rear panel. (Figure 3.2)

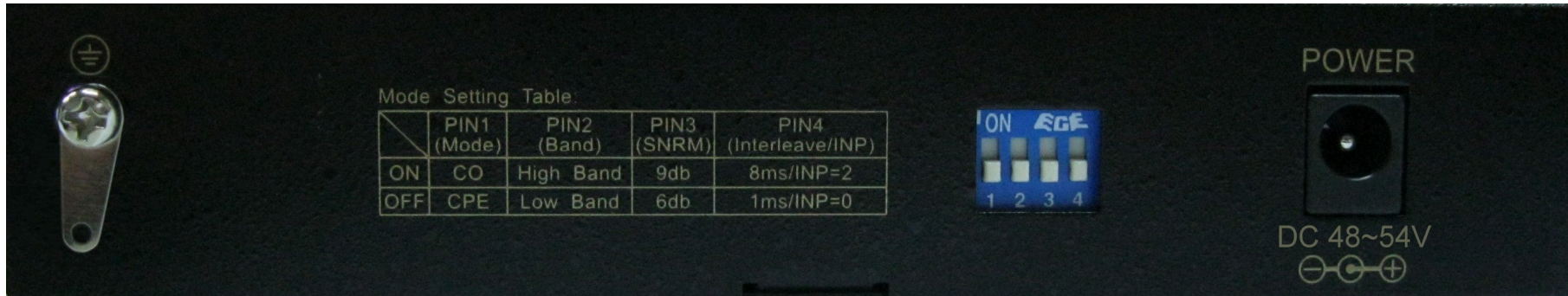



Figure 3.2 Rear Panel

And the table shows the description. (Table 3-3)

Table 3-3 Description of the bridge front connectors

Connectors	Type	Description
Power	DC Power Jack	External Power Adapter: Input: AC 100~240Volts/50~60Hz Output: DC 48V~54V/1.875A
DIP Switch	4 Pins DIP Switch	Provide 4 selectable transmission modes.
Ground 	Earthing strip	Please connect the ground lug to the earth. To prevent an electric shock when user touches.

The following figure shows the DIP switch connection. By switching the transmission modes, you can obtain a best transmission mode to suit with phone line quality or distance or connectivity. (Figure 3.3)

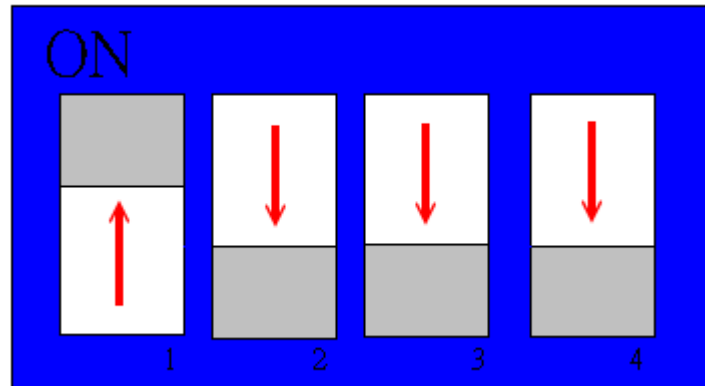

Figure 3.3 DIP switch setting

The following is table of DIP Switch configuration. (Table 3-4)

Table 3-4 DIP Switch Configuration

On/OFF	Pin 1	Pin 2	Pin 3	Pin 4
	CO/CPE Mode	Band	SNRM	Interleave / INP
On	CO Mode	High Band	9db	8ms / INP=2
Off	CPE Mode	Low band	6db	1ms / INP=0

Note:

1. The DIP switch default values are OFF.
2. Please power off NV-202P, before making any transmission mode configuration.

◆ **PIN1:**

ON: CO (Central Office) Mode or called Local Side, usually the CO device will be located at the data enter of enterprise to link to the backbone.

OFF: CPE (Customer Premises Equipment) Mode or called Remote Side, usually the CPE side will be located at factory, weather station, and train station as the long reach data receiver.

Tip:

When the NV-202P operates at **CPE** mode, the DIP switch 2, 3, 4 has **no function**.

◆ **PIN2:**

ON: High Band Mode (500 KHz to 30MHz), and enable VDSL2 spectrum is 500 KHz to 30MHz. It can pass through **ISDN** spectrum (0 ~ 499 KHz are empty).

OFF: Low Band Mode (300 KHz to 30MHz), the NV-202P will auto-detect the cable length and auto choice speed mode.

◆ **PIN3:**

When SNR margin is selected, the system provide **6db/9db** SNR margin for across all usable loop length. Please note that the 6db SNR margin is for telecom standard. Generally speaking, the higher SNR value gets better line quality, but lower performance.

◆ **PIN4:**

ON: Interleaved mode has a maximum end to end latency of **8m** sec and **INP=2**. When field environment has heavy noise, in order to obtain high link quality, user can configure pin4 to "ON", but this function will **reduce performance**.

OFF: Interleaved mode provides impulse noise protection for any impulse noise with duration less than **1ms**.

TIP(Reference Only):

Interleave delay function is used in digital data transmission technology to protect the transmission against noise issue and data error.

If during transit more than a certain amount of data has been lost then the data cannot be correctly decoded. Short bursts of noise on the line can cause these data packets to become corrupt and the bridge has to re-request data which in turn can slow down the overall rate at which data is transmitted.

Interleaving is a method of taking data packets, chopping them up into smaller bits and then rearranging them so that once contiguous data is now spaced further apart into a non continuous stream. Data packets are re-assembled by your bridge.

The diagram below is an example of how interleaved traffic is transmitted.

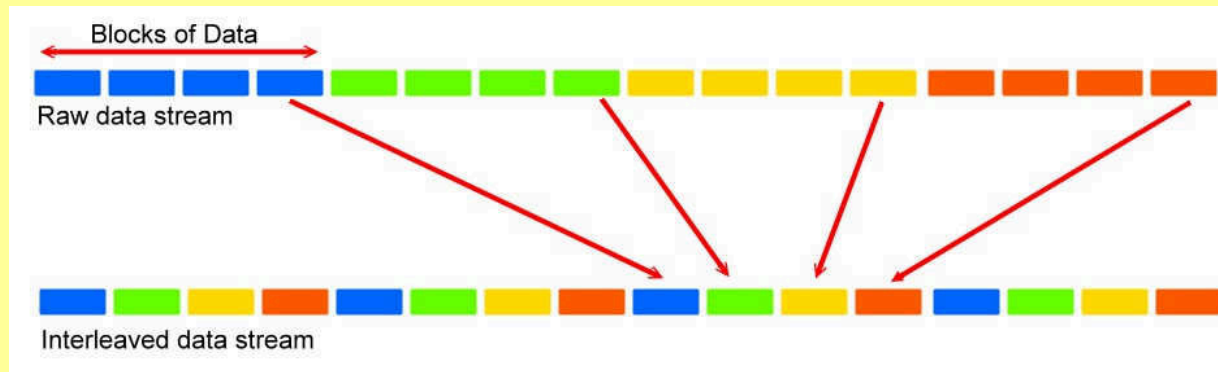

If your line is particularly susceptible to bursts of noise then interleaving should improve your VDSL2 experience simply because if you lose a whole batch of data then this could cause your bridge to lose sync with the exchange.

Using Interleaving, the bridge is able to re-assemble the data or if necessary just re-request the part of the data that it is unable to recover. By increasing the interleave depth of each ports that are susceptible to noise, this will improve error performance and stability of marginal lines.

INP (Impulse Noise Protection): Impulse noise in multicarrier communication systems behaves effectively as a modulating signal that controls the first moment of the background Gaussian noise. The composite noise, which is the aggregate of the Gaussian noise and impulse noise, has a probability density function that is conditionally Gaussian with non-zero average, hence referred to as biased-Gaussian. The BER-equivalent power of the composite noise source is defined as the power of a pure Gaussian noise source that yields the same bit-error rate (BER). The BER-equivalent noise for a biased-Gaussian noise is simply the amplified version of the underlying Gaussian noise source. The amplification factor is derived from the characteristics of the impulse interference. Any bit-loading algorithm designed for Gaussian noise sources is also applicable to biased-Gaussian noise sources provided that the BER-equivalent SNR is used in place of the measured SNR.

SNRM (Signal to Noise Ratio Margin): It's very similar to a conversation at a party and it's dealt with in the same way; we naturally account for both distance from the other person and the amount of background noise. When we do we don't just talk loud enough to be heard, we speak a bit louder waiting for the idiot with the stupid, loud laugh to start up again. We add a bit extra on to make sure we're louder than the average change in background noise.

That ratio is a major factor in determining the connection speed, as the higher the ratio the higher the possible speed. The SNRM is a margin which by which the noise level can rise before connection is lost.

Safety Caution!

- 1. Be sure to disconnect the power when installing (uninstalling) the terminal block and power cable.**
- 2. Please note that the NV-202P use 48V~54V DC power input. Do not exceed DC 54V.**
- 3. Be sure to disconnect the power before installing and/or wiring your NV-202P bridge.**
- 4. Please calculate the maximum possible current in each power wire and common wire. Observe all electrical codes dictating the maximum current allowable for each wire size. If the current goes above the maximum ratings, the wiring could overheat, causing serious damage to your equipment.**

Grounding the NV-202P

NV-202P is designed to enhance EMS performance by grounding. NV-202P comes with for grounding the switches. For optimal EMS performance, connection of the left side of the NV-202P rear panel ground lug to the grounding point.

Before user installed power and device, please read and follow these essentials:

- ◆ Use separate paths to route wiring for power and devices. If power wiring and device wiring paths must cross, make sure the wires are perpendicular at the intersection point.

Note:

Do not run signal or communications wiring and power wiring through the same wire conduit. To avoid interference, wires with different signal characteristics should be routed separately.

- ◆ You can use the type of signal transmitted through a wire to determine which wires should be kept separate. The rule of thumb is that wiring sharing similar electrical characteristics can be bundled together.
- ◆ You should separate input wiring from output wiring.
- ◆ We recommend that you mark all equipment in the wiring system.

Appendix A: Cable Requirements

Ethernet Cable

A CAT 3~7 UTP (unshielded twisted pair) cable is typically used to connect the Ethernet device to the bridge. A 10Base-T cable often consists of four pairs of wires, two of which are used for transmission. The connector at the end of the 10Base-T cable is referred to as an RJ-45 connector and it consists of eight pins. The Ethernet standard uses pins 1, 2, 3 and 6 for data transmission purposes. (Table A-1)

Table A-1 RJ-45 Ethernet Connector Pin Assignments

PIN #	MDI		MDI-X	
	Signal	Media Dependant interface	Signal	Media Dependant interface-cross
1	TX+	Transmit Data +	RX+	Receive Data +
2	TX-	Transmit Data -	RX-	Receive Data -
3	RX+	Receive Data +	TX+	Transmit Data +
4	Power injector+	+48V~54V	Output	+48V~54V
5	Power injector +	+48V~54V	Output	+48V~54V
6	RX-	Receive Data -	TX-	Transmit Data -
7	Power injector -	GND	GND	GND
8	Power injector -	GND	GND	GND

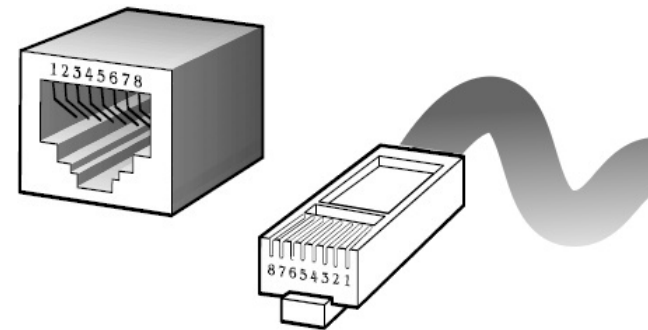

Figure A-1 Standard RJ-45 receptacle/connector

Note:

Please make sure your connected cables are with same pin assignment as above table before deploying the cables into your network.

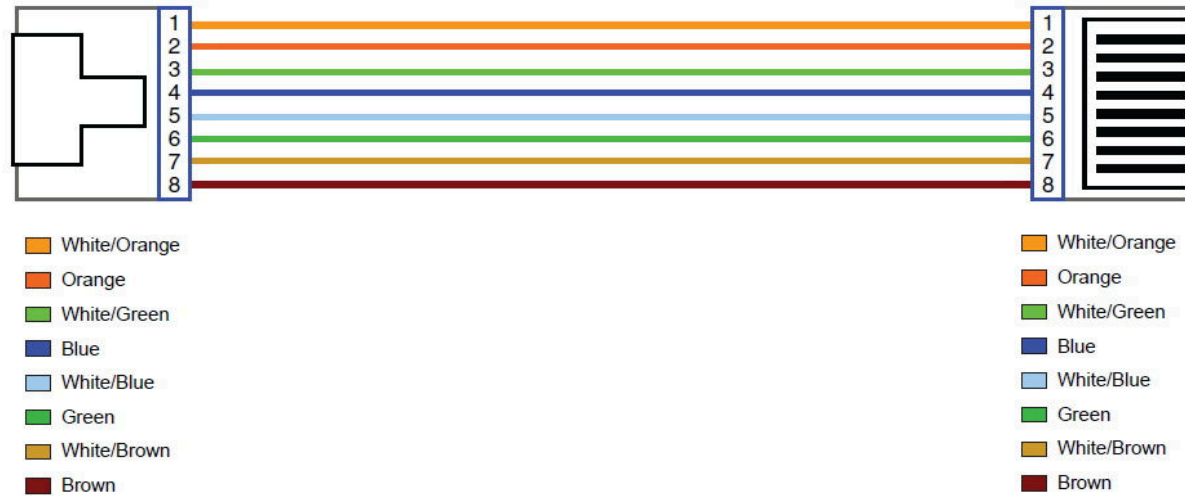

Figure A-2 Pin Assignments and Wiring for an RJ-45 Straight-Through Cable

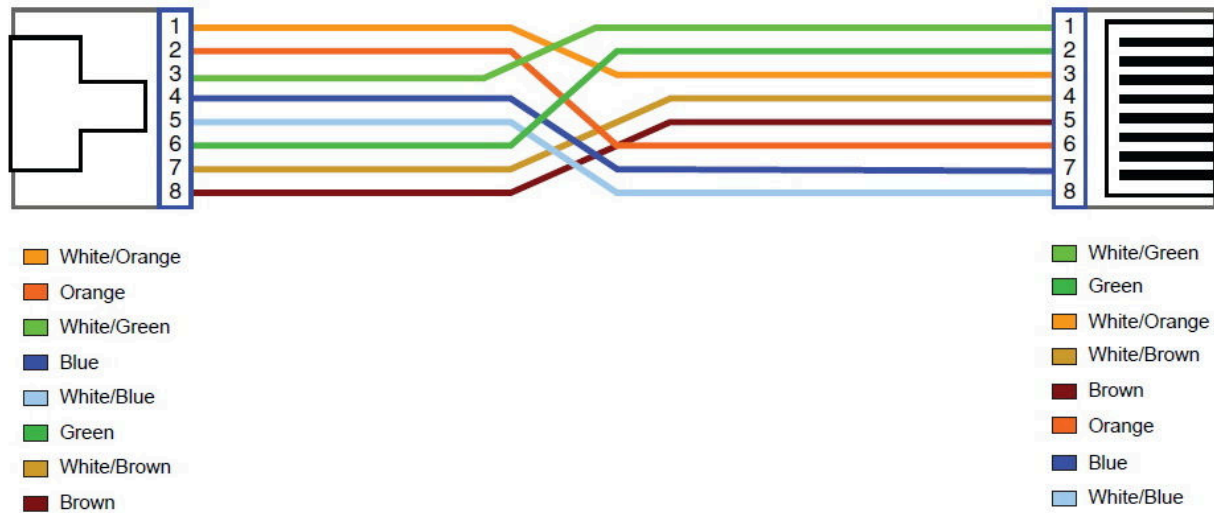

Figure A-3 Pin Assignments and Wiring for an RJ-45 Crossover Cable

Appendix B: Product Specification

Key Features & Benefits

- Provides 2 x 10/100 Mbps RJ-45 Ethernet ports with power injector
- Supports RJ-11/Terminal Block combo for Line port.
- Supports high bandwidth up to 100Mbps symmetric over Line ports
- Support long reach mode up to 3 km with 24 gauge phone wire
- DIP switch with CO and CPE mode selectable
- Support auto speed for Line port and Interleave mode selectable through CO side DIP switch
- Supports long packet size up to 1536 bytes
- Supports Surge protection
- Auto-detect of PoE IEEE 802.3af/at(up to 30 W) equipment providing protection from incorrect installation
- Supports mid-span PoE mode
- Supports wall mounting and DIN-Rail mount installation (Optional)
- Supports point-to-point applications

Product Specification

Standard:	<p>Compliant IEEE802.3 10 Base-TX standard Compliant IEEE802.3u 100 Base-TX standard Compliant IEEE802.3af / IEEE802.3at standard Compliant ITU-T G993.2 VDSL2 standard</p>
Physical Interface:	<p>2 x RJ-45 10/100Mbps auto-negotiation Ethernet port with power injector 1 x RJ-11/Terminal Block connector for VDSL2 port 1 x DIP Switch 1 x Power Jack MTU: 1536 bytes</p>
Power & PoE:	<p>Input Voltage: 48V ~ 54V DC (Commercial-grade desktop Power Adapter) Output: 30 W max for each . (Pin Assignment: 4/5(+), 7/8(-))</p>
LED Indicators:	<p>1 x Power LED 2 x Link/Active Status for Ethernet port 2 x PoE Indicator LED 1 x Link LED for VDSL2 line port 1 x CO Mode indicator LED 1 x CPE Mode indicator LED</p>
VDSL2 Line Code:	Discrete multitone (DMT) modulation
VDSL 2Transmission Mode:	Packet Transfer Mode (PTM)

EMC:	EMI Compliant: FCC class B EMS Compliant: CE mark
Operating Temperature:	0°C ~ 50°C (32°F ~ 122°F) Fanless, free air cooling
Storage Temperature:	-20°C ~ 70°C (-4°F ~ 158°F)
Humidity:	10% to 90% (non-condensing)
Weight:	About 423g
Dimensions:	137 x 100 x 27 mm (5.39" x 3.94" x 1.06")

Appendix C: DIN-Rail mount installation

This appendix describes how to install the DIN-Rail to the bridged. The accessory is optional.

◆ Please refer to install the DIN-RAIL as following step:

1. Install the DIN-Rail mounting plate to the NV-202P. (Figure C-1)
2. Please use the suitable DIN-Rail to install, please refer to the dimensions of the DIN-Rail.(Figure C-2)
3. Insert the top of the DIN-Rail into the top slots on the DIN-Rail mounting plate and the DIN-Rail mounting plate will snap into place. (Figure C-3)

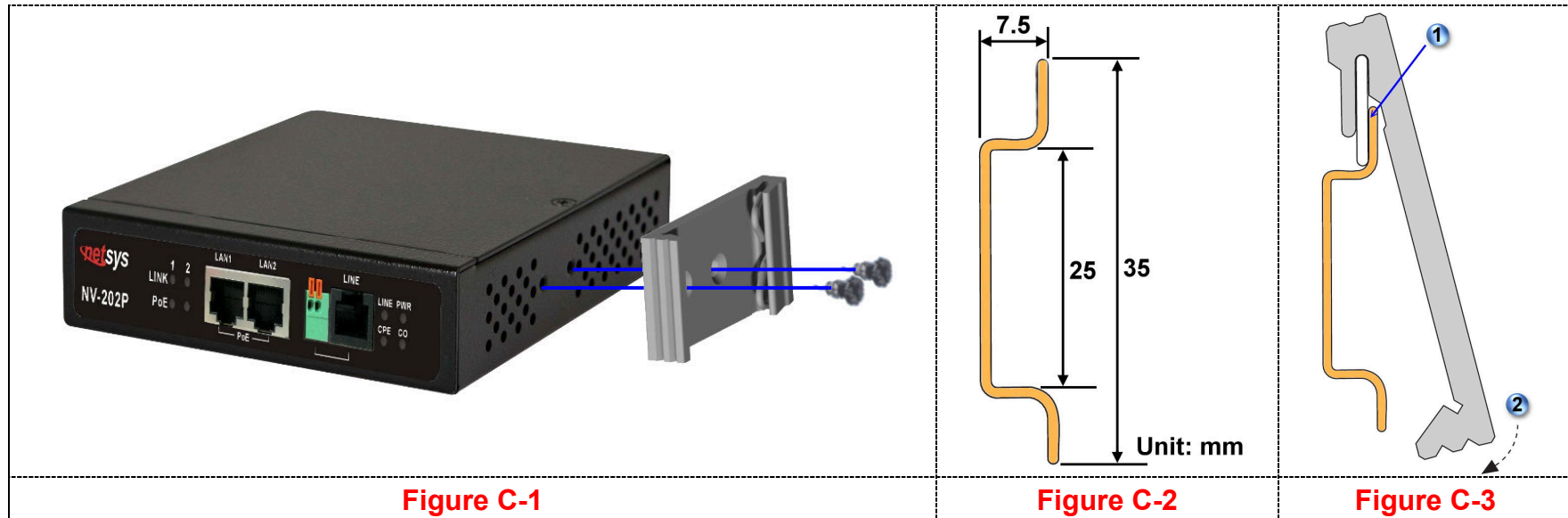

Appendix D: Troubleshooting

Diagnosing the Bridge's Indicators

The bridge can be easily monitored through its comprehensive panel indicators. These indicators assist the network manager in identifying problems the hub may encounter. This section describes common problems you may encounter and possible solutions.

1. Symptom:	POWER indicator does not light up (green) after power on.
Cause:	Defective External power supply
Solution:	Check the power plug by plugging in another that is functioning properly. Check the power cord with another device. If these measures fail to resolve the problem, have the unit power supply replaced by a qualified distributor.
2. Symptom:	Link indicator does not light up (green) after making a connection.
Cause:	Network interface (ex. a network adapter card on the attached device), network cable, or switch port is defective.
Solution:	2.1 Power off and re-power on the VDSL bridged. 2.2 Verify that the bridge and attached device are power on. 2.3 Be sure the cable is plugged into both the bridge and corresponding device. 2.4 Check if the proper cable type is used and its length exceed specified limits. 2.5 Check the bridge on the attached device and cable connections for possible defects. 2.6 Make sure the phone wire must be connecting NV-202P first, when powered on. 2.7 Replace the defective bridge or cable if necessary.

3. Symptom:	VDSL Link cannot be established.
Cause:	VDSL setting failure or phone cable length is over the specification limit.
Solution:	<p>3.1 Please make sure that the phone wire must be connected between NV-202P(CO) and NV-202(CPE) when both are power on. NV-202P(CO) will do link speed function depending on phone wire length, therefore if NV-202P(CO) can't detect NV-202(CPE) over phone wire while both power on, this will cause the link to fail.</p> <p>3.2 Please check the phone wire, we recommend use 24 gauge with twisted pair and without rust, and the length is not over 3 km.</p> <p>3.3 Please check the correct Dip Switch setting. (CO: PIN1 ON, CPE: PIN1 OFF)</p> <p>3.4 Please reinsert power adapter when changing cable length or link time over 3 minutes.</p>
Note:	Phone wire must meet CAT 3 standard or above and without clustering , otherwise will cause more cross talk issue to reduce DSL power driver.

4. Question:	What is VDSL2?
Answer:	<p>Very-high-speed digital subscriber line 2 (VDSL2) is an access technology that exploits the existing infrastructure of copper wires that were originally deployed for traditional telephone service. It can be deployed from central offices, from fiber-optic connected cabinets located near the customer premises, or within buildings. It was defined in standard ITU-T G.993.2 finalized in 2005.</p> <p>VDSL2 was the newest and most advanced standard of digital subscriber line (DSL) broadband wireline communications. Designed to support the wide deployment of triple play services such as voice, video, data, high definition television (HDTV) and interactive gaming, VDSL2 was intended to enable operators and carriers to gradually, flexibly, and cost-efficiently upgrade existing xDSL</p>

infrastructure.

The protocol was standardized in the International Telecommunication Union telecommunications sector (ITU-T) as Recommendation G.993.2. It was announced as finalized on 27 May 2005,[1] and first published on 17 February 2006. Several corrections and amendments were published in 2007 through 2011.

VDSL2 is an enhancement to very-high-bitrate digital subscriber line (VDSL), Recommendation G.993.1. It permits the transmission of asymmetric and symmetric aggregate data rates up to 200 Mbit/s downstream and upstream on twisted pairs using a bandwidth up to 30 MHz.

VDSL2 deteriorates quickly from a theoretical maximum of 250 Mbit/s at source to 100 Mbit/s at 0.5 km (1,600 ft) and 50 Mbit/s at 1 km (3,300 ft), but degrades at a much slower rate from there, and still outperforms VDSL. Starting from 1.6 km (1 mi) its performance is equal to ADSL2+.

ADSL-like long reach performance is one of the key advantages of VDSL2. LR-VDSL2 enabled systems are capable of supporting speeds of around 1–4 Mbit/s (downstream) over distances of 4–5 km (2.5–3 miles), gradually increasing the bit rate up to symmetric 100 Mbit/s as loop-length shortens. This means that VDSL2-based systems, unlike VDSL1 systems, are not limited to short local loops or MTU/MDUs only, but can also be used for medium range applications.

5. Question:	What is SNR(Signal-to-Noise)
Answer:	<p>Signal-to-noise ratio (often abbreviated SNR or S/N) is a measure used in science and engineering that compares the level of a desired signal to the level of background noise. It is defined as the ratio of signal power to the noise power. A ratio higher than 1:1 indicates more signal than noise. While SNR is commonly quoted for electrical signals, it can be applied to any form of signal (such as isotope levels in an ice core or biochemical signaling between cells). The ratio is usually measured in decibels(dB)</p> <p>The signal-to-noise ratio, the bandwidth, and the channel capacity of a communication channel are connected by the Shannon–Hartley theorem.</p> <p>In digital communications, the SNR will probably cause a reduction in data speed because of frequent errors that require the source (transmitting) computer or terminal to resend some packets of data. SNR measures the quality of a transmission channel over a network channel. The greater the ratio, the easier it is to identify and subsequently isolate and eliminate the source of noise.</p>

6. Question:	Connected the Co and CPE within 300 meters RJ-11 phone cable got only less than 10 Mbit/s
Cause:	<ol style="list-style-type: none"> 1. Some testing program which is base on TCP/IP protocol such as FTP, Iperf, NetIQ, the bandwidth of testing outcome will be limited by TCP window size. 2. Some operating system limited the maximum bandwidth, such as windows series OS.
Solution:	We recommend to test VDSL2 bandwidth best by Smartbit equipment (Packet generator), if you don't have Smartbit, we recommend test that by IPERF program, and TCP window size must be setted max. 64k, the parameter as iperf -c server IP address -i 1 -t 50 -w 65535 for client side.

System Diagnostics

Power and Cooling Problems

If the POWER indicator does not turn on when the power cord is plugged in, you may have a problem with the power outlet, power cord, or internal power supply. However, if the unit power is off after running for a while, check for loose power connections, power losses or surges at the power outlet. If you still cannot isolate the problem, then the internal power supply may be defective. In this case, please contact your local dealer.

Installation

Verify that all system components have been properly installed. If one or more components appear to be malfunctioning (e.g. the power cord or network cabling), test them in an alternate environment where you are sure that all the other components are functioning properly.

Transmission Mode

The default method of selecting the transmission mode for RJ-45 ports is 10/100 Mbps ETHERNET, for RJ-11 port are auto-negotiation VDSL. Therefore, if the Link signal is disrupted (e.g. by unplugging the network cable and plugging it back in again, or by resetting the power), the port will try to reestablish communications with the attached device via auto-negotiation. If auto-negotiation fails, then communications are set to half duplex by default. Based on this type of industry-standard connection policy, if you are using a full-duplex device that does not support auto-negotiation, communications can be easily lost (i.e. reset to the wrong mode) whenever the attached device is reset or experiences a power fluctuation. The best way to resolve this problem is to upgrade these devices to a version that support Ethernet and VDSL.

Physical Configuration

If problems occur after altering the network configuration, restore the original connections, and try to track the problem



down by implementing the new changes, one step at a time. Ensure that cable distances and other physical aspects of the installation do not exceed recommendations.

System Integrity

As a last resort verify the switch integrity with a power-on reset. Turn the power to the switch off and then on several times. If the problem still persists and you have completed all the preceding diagnoses, then contact your dealer.

Appendix E: Compliance Information

FCC Radio Frequency Interference Statement

This equipment has been tested and found to comply with the limits for a computing device, pursuant to Part 15 of FCC rules. These limits are designed to provide reasonable protection against harmful interference when the equipment is operated in a commercial environment. This equipment generates uses and can radiate radio frequency energy and, if not installed and used in accordance with the instructions, may cause harmful interference to radio communications. However, there is no guarantee that interference will not occur in a particular installation. If this equipment does cause harmful interference to radio or television reception, which can be determined by turning the equipment off and on, the user is encouraged to try to correct the interference by one or more of the following measures:

1. Reorient or relocate the receiving antenna.
2. Increase the separation between the equipment and receiver.
3. The equipment and the receiver should be connected to outlets on separate circuits.
4. Consult the dealer or an experienced radio/television technician for help.

Changes or modifications not expressly approved by the party responsible for compliance could void the user's authority to operate the equipment.

If this telephone equipment causes harm to the telephone network, the telephone company will notify you in advance that temporary discontinuance of service may be required. But if advance notice isn't practical, the telephone company will notify the customer as soon as possible. Also, you will be advised of your right to file a complaint with the FCC if you believe it is necessary.

The telephone company may make changes in its facilities, equipment, operations or procedures that could affect the

proper functioning of your equipment. If they do, you will be notified in advance in order for you to make necessary modifications to maintain uninterrupted service.

This equipment may not be used on coin service provided by the telephone company. Connection to party lines is subject to state tariffs.

FCC Warning



This equipment has been tested to comply with the limits for a Class B digital device, pursuant to Part 15 of the FCC Rules. These limits are designed to provide reasonable protection against harmful interference when the equipment is operated in a commercial environment. This equipment can generate, use, and radiate radio frequency energy and, if not installed and used in accordance with the instruction manual, may cause harmful interference to radio communications. Operation of this equipment in a residential area is likely to cause harmful interference in which case the user will be required to correct the interference at owner's expense.

CE Mark Warning



This is a class B product. In a domestic environment, this product may cause radio interference in which case the user may be required to take adequate measures.

RoHS Mark Warning



RoHS stands for Restriction of Hazardous Substances, and impacts the entire electronics industry and many electrical products as well. The original RoHS, also known as Directive 2002/95/EC, originated in the European Union in 2002 and restricts the use of six hazardous materials found in electrical and electronic products. All applicable products in the EU market since July 1, 2006 must pass RoHS compliance. Directive 2011/65/EU was published in 2011 by the EU, which is known as RoHS-Recast or RoHS 2. RoHS 2 includes a **CE-marking directive**, with RoHS compliance now being required for CE marking of products. RoHS 2 also added Categories 8 and 9, and has additional compliance recordkeeping requirements. Directive 2015/863 was published in 2015 by the EU, which is known as RoHS 3. RoHS 3 adds four additional restricted substances (phthalates) to the list of six.

WEEE Warning



To avoid the potential effects on the environment and human health as a result of the presence of hazardous substances in electrical and electronic equipment, end users of electrical and electronic equipment should understand the meaning of the crossed-out wheeled bin symbol. Do not dispose of WEEE as unsorted municipal waste and have to collect such WEEE separately.

Warranty

The original product that the owner delivered in this package will be free from defects in material and workmanship for one year parts after purchase.

There will be a minimal charge to replace consumable components, such as fuses, power transformers, and mechanical cooling devices. The warranty will not apply to any products which have been subjected to any misuse, neglect or accidental damage, or which contain defects which are in any way attributable to improper installation or to alteration or repairs made or performed by any person not under control of the original owner.

The above warranty is in lieu of any other warranty, whether express, implied, or statutory, including but not limited to any warranty of merchantability, fitness for a particular purpose or any warranty arising out of any proposal, specification or sample. We shall not be liable for incidental or consequential damages. We neither assume nor authorize any person to assume for it any other liability.



WARNING:
DO NOT TEAR OFF OR REMOVE THE WARRANTY STICKER AS SHOWN, OR THE WARRANTY IS VOID.

Chinese SJ/T 11364-2014

部件名称	有毒有害物质或元素					
	铅(Pb)	汞(Hg)	镉(Cd)	六价铬[Cr(VI)]	多溴联苯(PBB)	多溴二苯醚(PBDE)
结构壳体	○	○	○	○	○	○
电路组	○	○	○	○	○	○
电源供应器	○	○	○	○	○	○
线材	○	○	○	○	○	○
包装及配件	○	○	○	○	○	○
○：表示该有毒物质在该部件所有均质材料中的含量均在 GB/T 25672 标准规定的限量要求以下。 ×：表示该有毒物质至少在该部件的某依均质材料中的含量超出 GB/T 26572 标准规定的限量要求。						

上述规范仅适用于中国法律